

DH-HAC-HFW1100B

1Megapixel 720P Water-proof HDCVI IR-Bullet Camera



Features

- 1/2.7" 1Megapixel CMOS
- 25/30fps@720P
- High speed, long distance real-time transmission
- Day/Night(ICR), AWB, AGC, BLC, 2DNR
- 3.6mm fixed lens (6mm, 8mm optional)
- Max. IR LEDs length 50m, Smart IR
- IP67, DC12V

DH-HAC-HFW1100B

Technical Specifications

Model	DH-HAC-HFW1100BP	DH-HAC-HFW1100BN
Camera		
Image Sensor	1/2.7" 1Megapixel CMOS	
Effective Pixels	1280(H)×720(V)	
Electronic Shutter	1/50s~1/100,000s	1/60s~1/100,000s
Video Frame Rate	25fps@720P	30fps@720P
Synchronization	Internal	
Min. Illumination	0.02Lux/F2.0, 0Lux IR on	
Video Output	1-channel BNC HDCVI high definition video output	
Camera Features		
Max. IR LEDs Length	50m, Smart IR	
Day/Night	Auto(ICR) / Color / B/W	
Noise Reduction	2D	
Lens		
Focal length	3.6mm (6mm, 8mm optional)	
Angle of View	H: 89.9° (59.4° /41.4°)	
Mount Type	M12	
General		
Power Supply	DC12V±20%	
Power Consumption	Max 4.5W	
Working Environment	-30°C~+60°C / Less than 95%RH (no condensation)	
Transmission Distance	Over 500m via 75-3 coaxial cable	
Ingress Protection	IP67	
Dimensions(W×D×H)	241.8mm×90.2mm×83.7mm	
Weight	0.635kg	
Material	Metal	

DH-HAC-HFW1200B

Dimensions (mm)

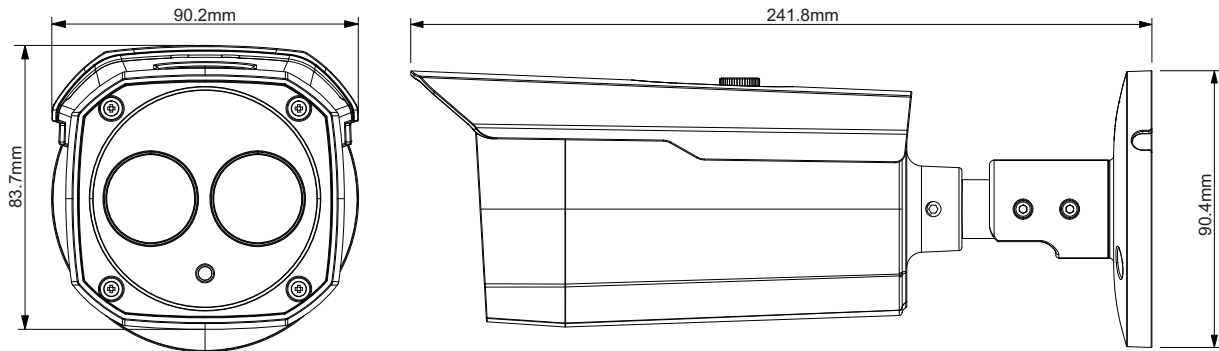

Accessories (optional)

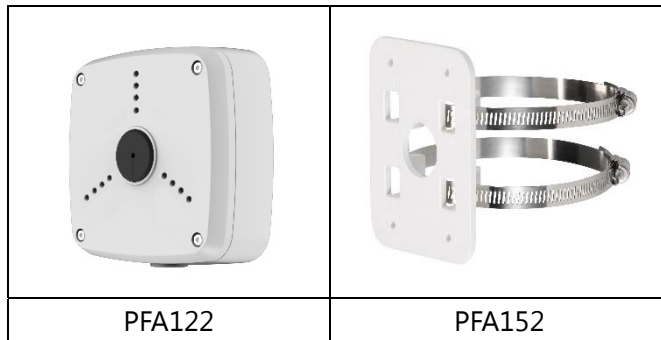

Dahua Technology Co., Ltd.

1187 BinAn Road, Binjiang District, Hangzhou, China

Tel: +86-571-87688883

Fax: +86-571-87688815

Email: overseas@dahuatech.com

www.dahuasecurity.com

*Design and specifications are subject to change without notice.

© 2013 Dahua Technology Co., Ltd.