

Quick Installation Guide

Wireless N Gigabit Access Point

EAP120 / EAP220

7106505542 REV1.0.0

1 Network Topology Requirement

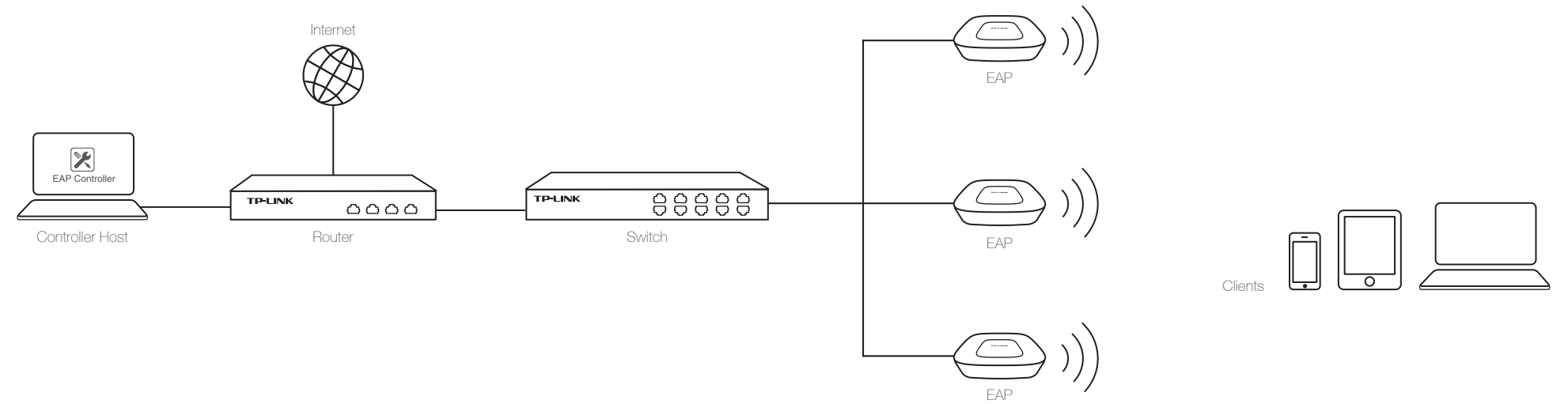





- A DHCP server (typically a router) is required to assign IP addresses to the EAP and clients in your local network.
- A computer running the EAP Controller software, which can be in the same or different subnet with the EAPs.

2 Hardware Overview

LED Indication



- | | |
|--|--|
|  Solid green
The device is working properly. |  Flashing yellow
Firmware update is in progress. Do not disconnect or power off the device. |
|  Flashing red
System errors. RAM, Flash, Ethernet, WLAN or firmware may be malfunctioning. |  Double-flashing red, green, yellow
The device is being reset to its factory default settings. |

Interface Panel

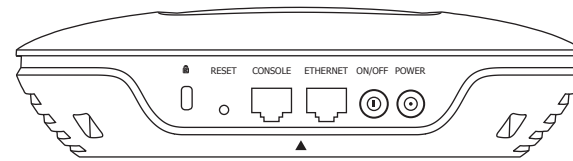

- RESET**
With the device powered on, press and hold the button for about 8 seconds until the LED flashes red, then release the button. The device will restore to factory default settings.
- CONSOLE**
The port is used to connect to the serial port of a computer or a terminal to check and monitor system information of the EAP device. CLI commands are not available in current software version. We will release a new version supporting CLI commands soon. Please pay close attention to our official website.
- ETHERNET**
The port is used to connect to a router or a switch to transmit data or to a PSE (Power Sourcing Equipment), such as a PoE switch, for both data transmission and Power over Ethernet (PoE) through Ethernet cabling.
- ON/OFF**
Press this button to turn on or turn off the EAP device.

3 Hardware Installation

The EAP can be ceiling rail mounted, ceiling-mounted, and wall-mounted. The instructions for various mounting options are on the back of this Quick Installation Guide.

Option 1: Ceiling Rail Mounting

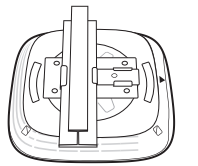

Option 2: Ceiling Mounting

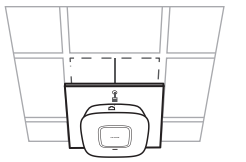

Option 3: Wall Mounting

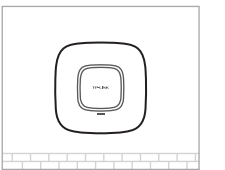

4 Power Supply

EAP can be powered via a PSE device (such as a PoE switch) or a power adapter.

Via PoE Switch

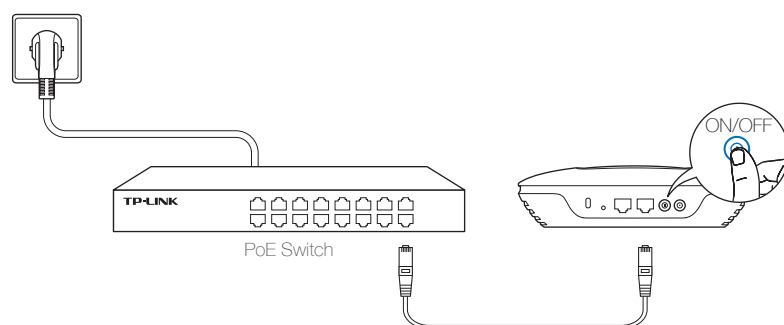

1. Connect the Ethernet cable from the PoE switch to the ETHERNET port.
2. Press the ON/OFF button on the interface panel of the EAP.

Via Power Adapter

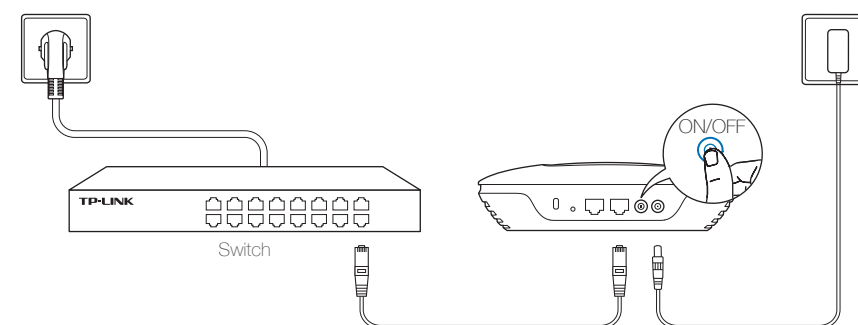

1. Plug one end of the provided power adapter into the POWER port of the EAP and the other end to a standard electrical wall outlet.
2. Press the ON/OFF button on the interface panel of the EAP.

5 Software Configuration

To quickly set up a wireless network connection with mass EAPs, please follow the steps below. Note: The IP address of the management computer must be reachable for the EAPs in the network.

Step 1: Installing the EAP Controller

Find the EAP Controller application file on the Resource CD (for Windows user only) or from our website at www.tp-link.com. Run the file and follow the wizard to install the EAP Controller on the computer.

Step 2: Configuring the EAP Controller

Launch the EAP Controller and follow the configuration wizard to create a primary wireless network. After the wizard is finished, a login screen will appear. Enter the admin name and password you created and click Sign In.

Step 3: Adopting the EAP devices

Adopt the EAP devices in the Controller management interface to change the status from pending to connected.

For More Configurations

Now you can manage your wireless network and view network statistic using the EAP Controller. Please refer to the EAP Controller User Guide to learn more information on configuring and using the Controller software.

Option 1: Ceiling Rail Mounting

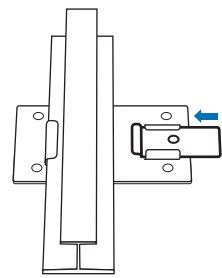
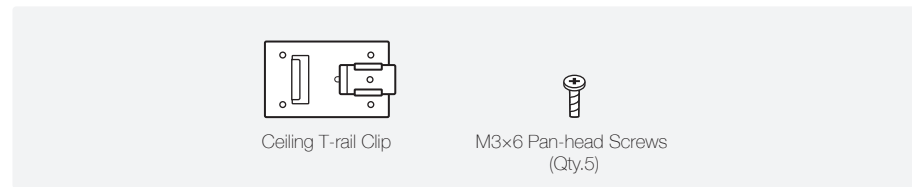

1 Position the Ceiling T-rail Clip and push the movable part toward the rail base.

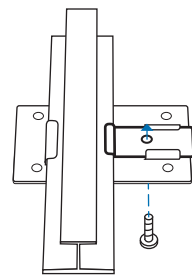

2 Use an M3x6 pan-head screw to secure the T-rail Clip onto the ceiling rail.

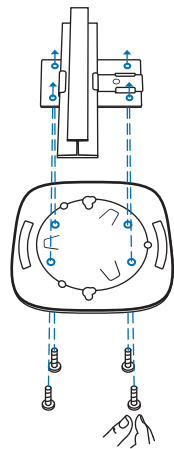

3 Attach the mounting bracket to the Ceiling T-rail Clip using four M3x6 pan-head screws.

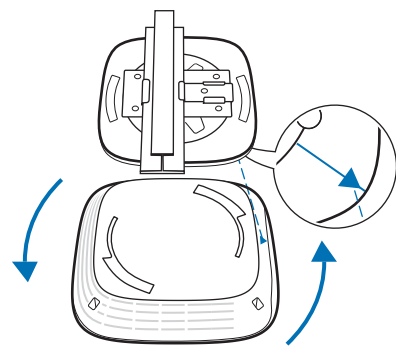

4 Attach the EAP to the mounting bracket by aligning ARROW 1 (on the EAP) with ARROW 2 (on the mounting bracket), then rotate the EAP clockwise until it locks into place.

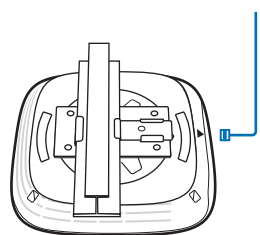

5 Connect the Ethernet cable to the ETHERNET port.

Option 2: Ceiling Mounting

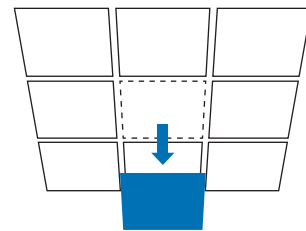
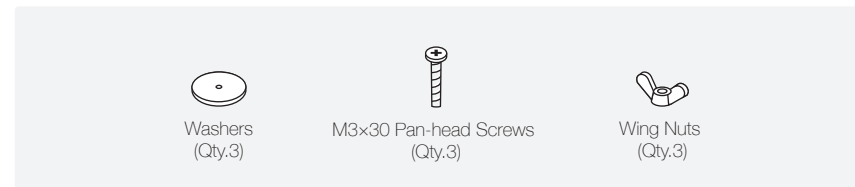

1 Remove the ceiling tile.

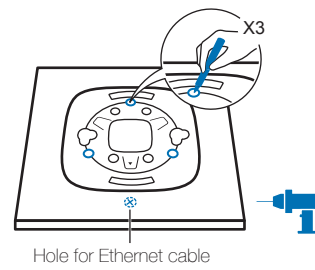

2 Place the mounting bracket in the center of the ceiling tile. Mark the three positions of the screw holes and a 10mm hole for the Ethernet cable to feed through. Drill three 4mm holes and a 10mm hole for the Ethernet cable.

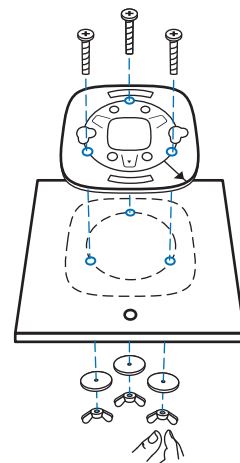

3 Secure the mounting bracket to the ceiling tile using three M3x30 pan-head screws, washers and wing nuts, as shown on the left.

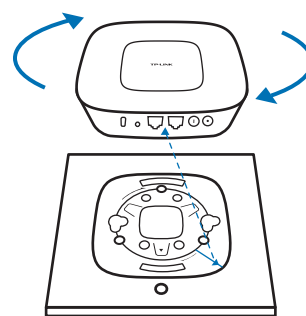

4 Attach the EAP to the mounting bracket by aligning ARROW 1 (on the EAP) with ARROW 2 (on the mounting bracket), then rotate the EAP clockwise until it locks into place.

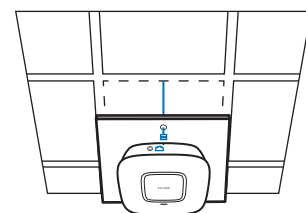

5 Feed the Ethernet cable through the hole and set the ceiling tile back into place. Connect the Ethernet cable to the ETHERNET port.

Option 3: Wall Mounting

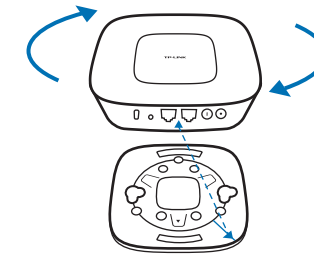
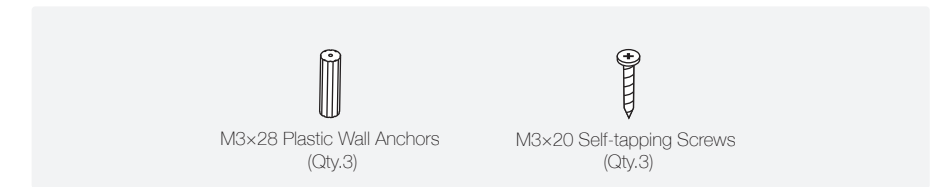

1 Attach the EAP to the mounting bracket by aligning ARROW 1 (on the EAP) with ARROW 2 (on the mounting bracket), then rotate the EAP clockwise until it locks into place.

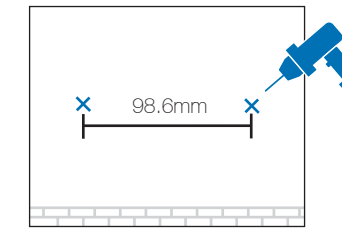

2 Make two small pencil marks on the wall. Make sure the two marks are level and should be 98.6mm apart. Drill two 6mm holes through the center of your marks.

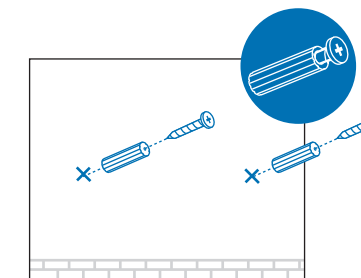

3 Insert the plastic wall anchors into the 6mm holes and drive the self-tapping screws into the anchors. Do not drive the screws all the way in and leave enough clearance to hang the EAP.

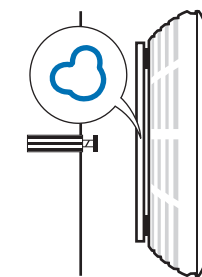

4 Hang the EAP on the screws. Make sure the EAP is firmly seated against the wall.

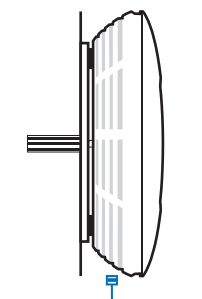

5 Connect the Ethernet cable to the ETHERNET port on the EAP.